

SECTION A-A

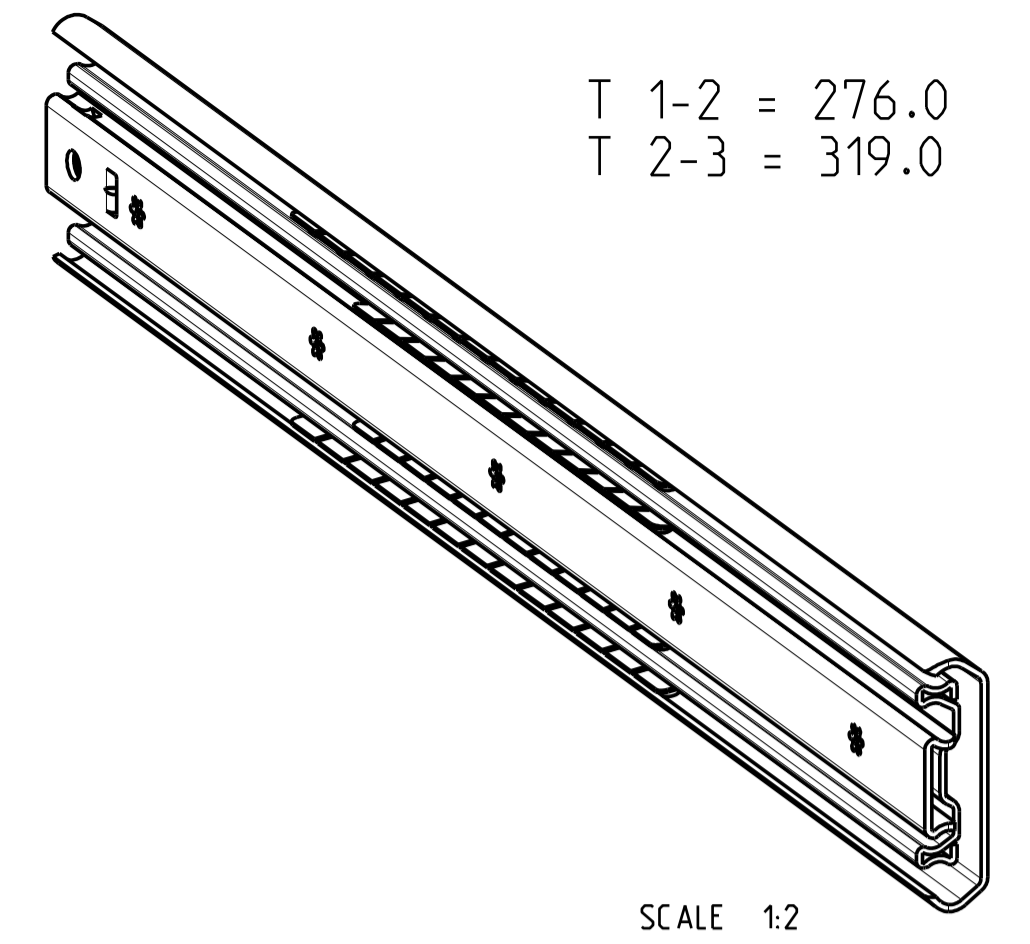

T 1-2 = 276.0
T 2-3 = 319.0

SCALE 1:2

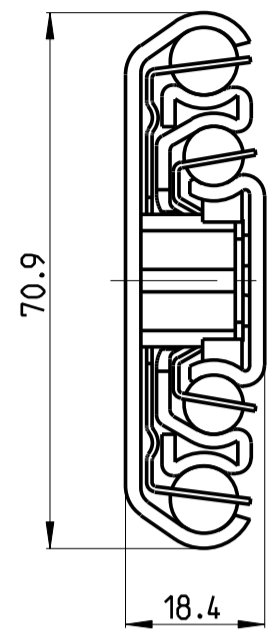

70.9
18.4

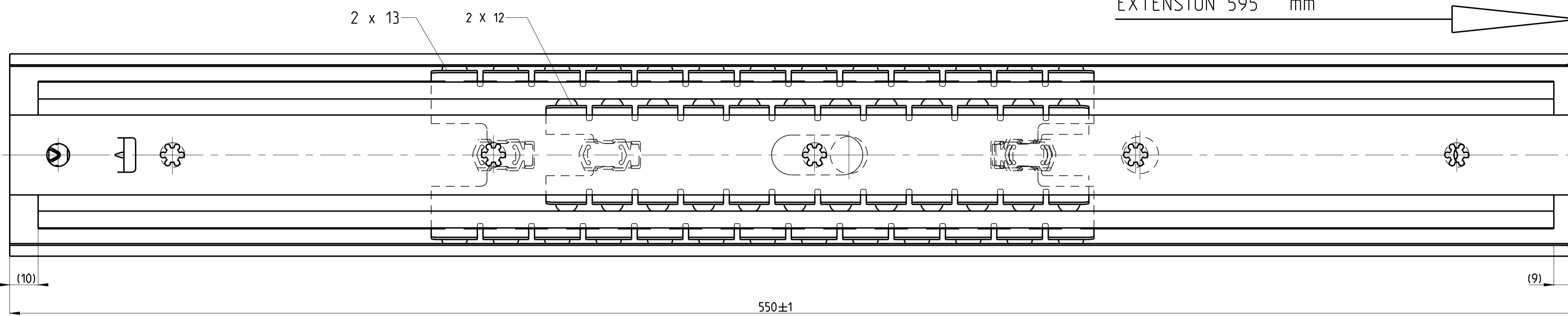

EXTENSION 595±4 mm

550±1

FRONT

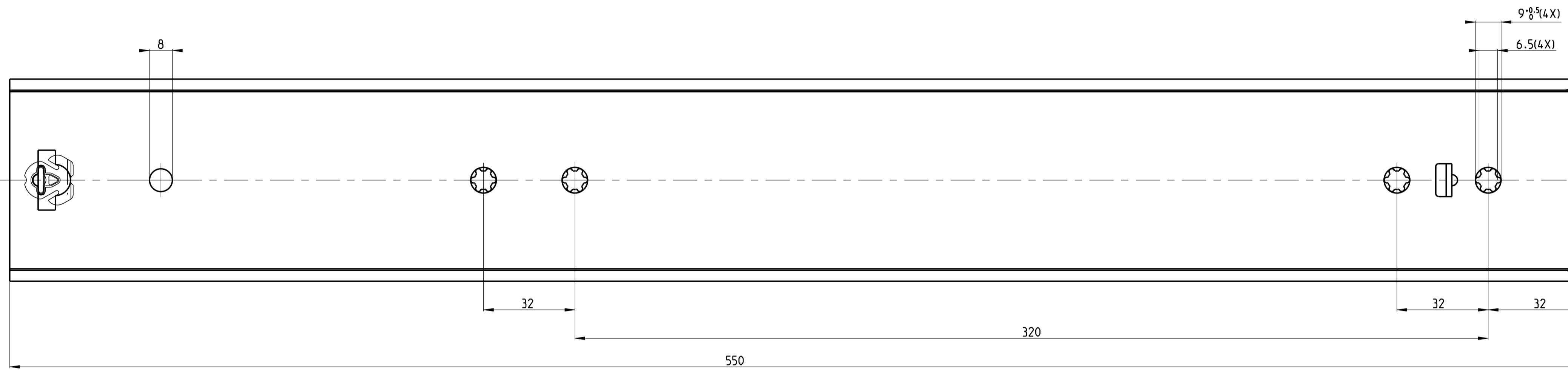
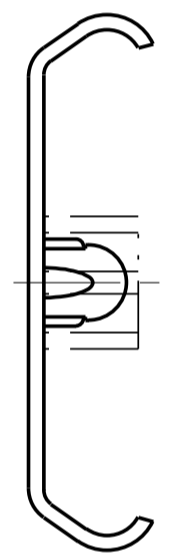

511-01-S26-TA1

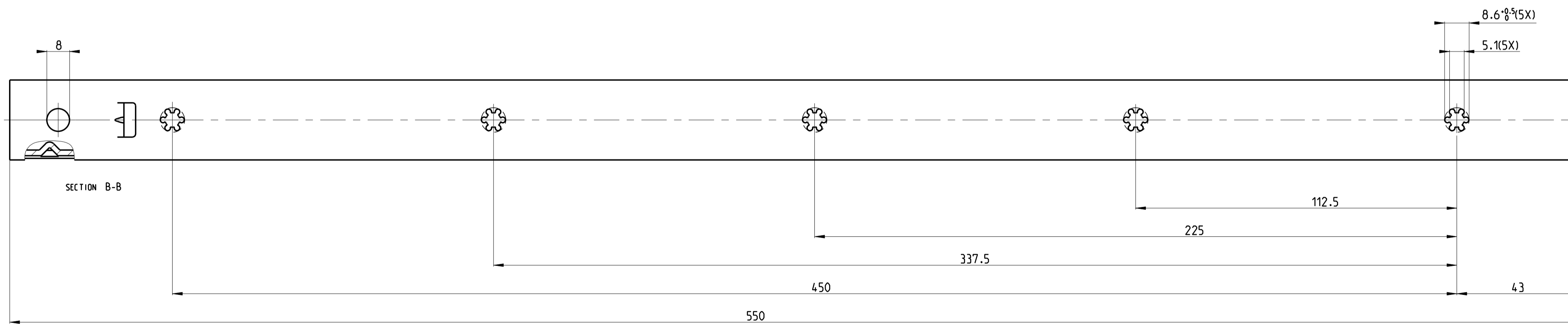
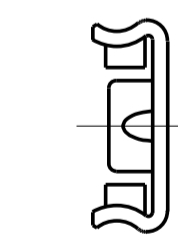

513-01-S26-TA3

PRO/ENGINEER Drawing		Dimensions between marks are guide dimensions.		Thomas Regout Int. B.V. reserves the right to alter non-customer specific specifications without notice.	
Was: - 101-525-03		Tolerances unless otherwise stated ±0.5mm.			
American projection	DIMENSION	mm	MAT.:	-	
	SCALE	1:1	REM.:	RIGHT HAND SLIDE = LEFT HAND SLIDE	
	DATE	25-08-2011			
	DESIGNER	M. Mahieu		TYPE D	
	CHECKED	-			
TITAN 550.0 / 595.0 (18,5mm)					
THOMAS REGOUT INTERNATIONAL BV			Drw. Nr.	Format.	
© Thomas Regout International BV All rights are reserved.			101-S26 _ 00	A1	
			Production		

04	-	-	05	-	-	-	-	06	-	-	-	-
01	-	-	02	-	-	-	-	03	-	-	-	-