

T 1-2 = 10,866 in
T 2-3 = 12,756 in

A-A (1:1)

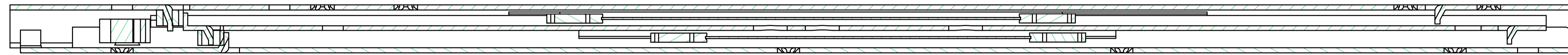

EXTENSION 23,622 in

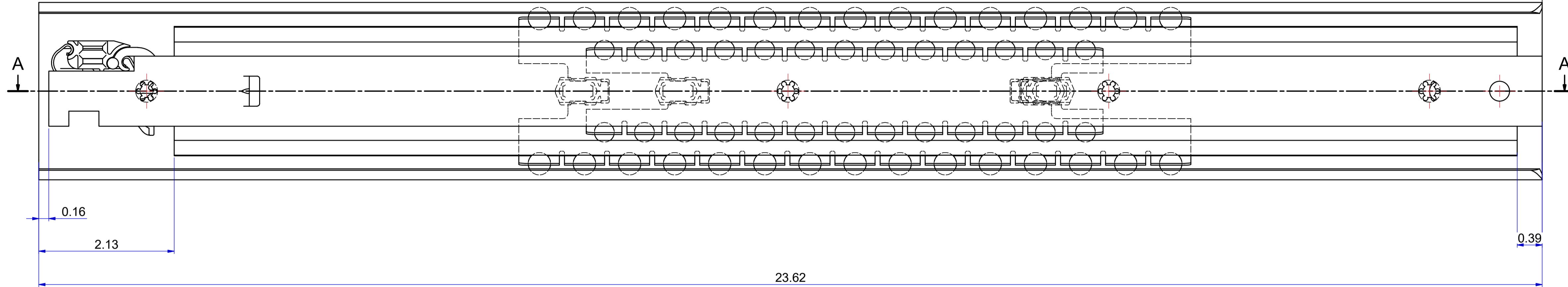
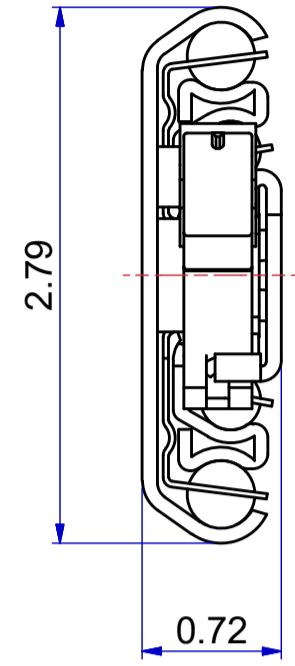

NOT FOT CUSTOMER APPLICATION!

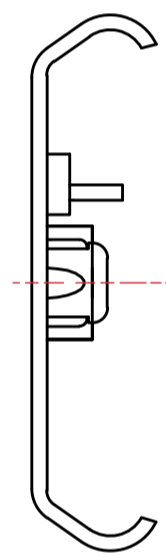

511-01-S67-TA1

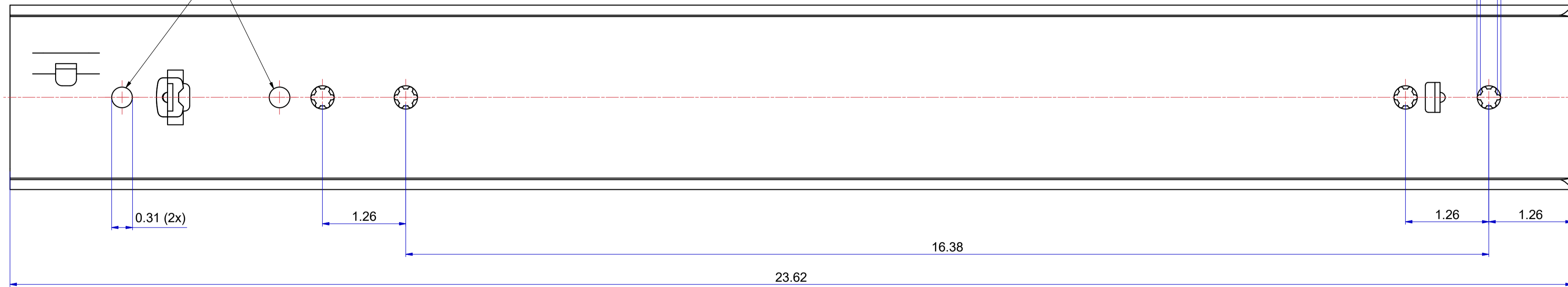

FRONT

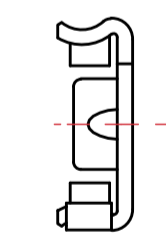

514-01-S67-TA3

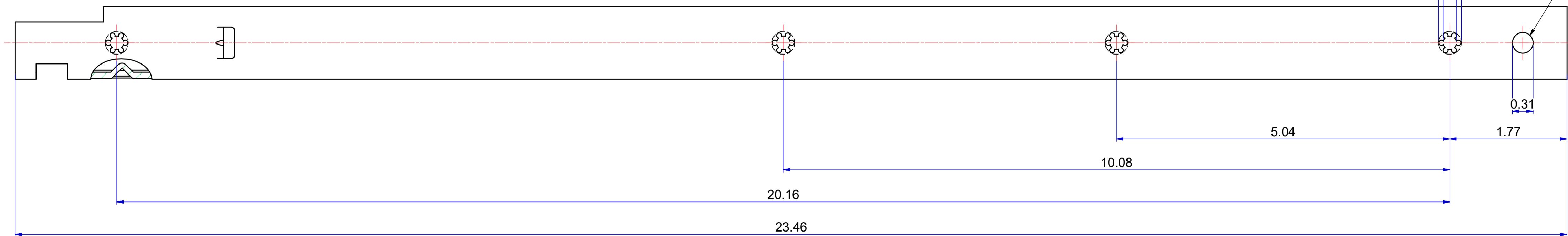

NOT FOT CUSTOMER APPLICATION!

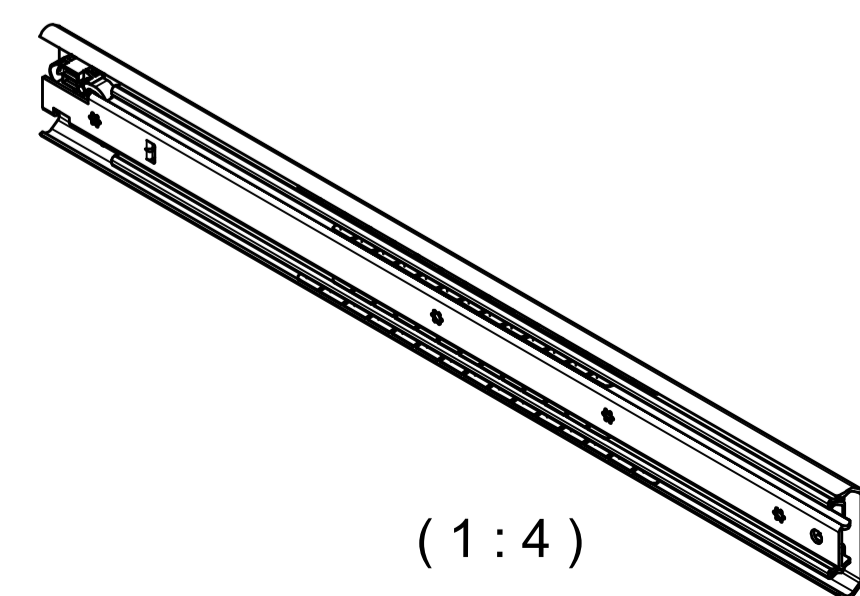

(1:4)

DIMENSIONS ARE CALCULATED FROM METRIC VALUES
THOMAS REGOUT B.V. RESERVES THE RIGHT TO ALTER NON-CUSTOMER
SPECIFICATIONS WITHOUT NOTICE

Designer	Gen.Tol.Dim.	Third angle projection	Material	Generic
Date	26-10-2015	Gen.Tol.Angle	Treatment	
Approver	Gen.Roughness		Draw type	Fabrication
Date	Units	Inch/deg	Scale	1 : 1
			Type	Model No. E000036323

Description
TITAN 600 / 600 (18,4mm) [23.62"/23.62"(0,724")]
Released for Production

Format	THOMAS REGOUT INTERNATIONAL B.V.	Item No.	Revision
A1		101-S67_Inch	00