

T 1 - 2 = 21,299 in

A-A (1:1)

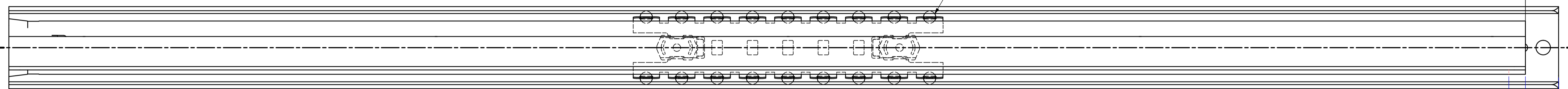

EXTENSION 21,299 in

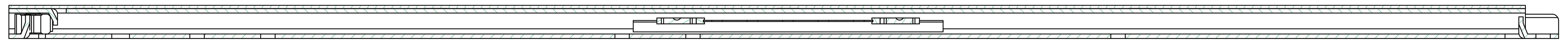
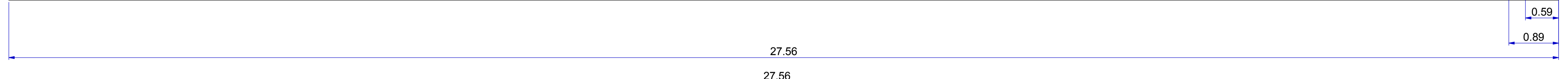

NOT FOR CUSTOMER APPLICATION !

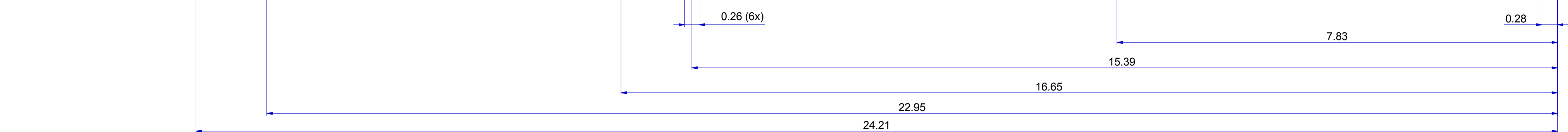
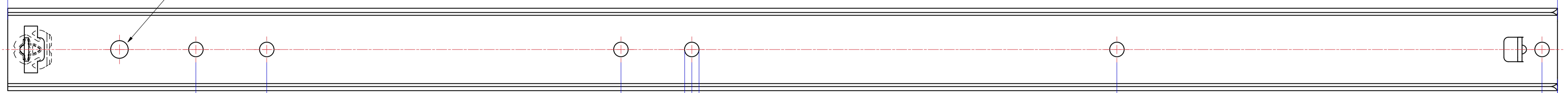

NOT FOR CUSTOMER APPLICATION !

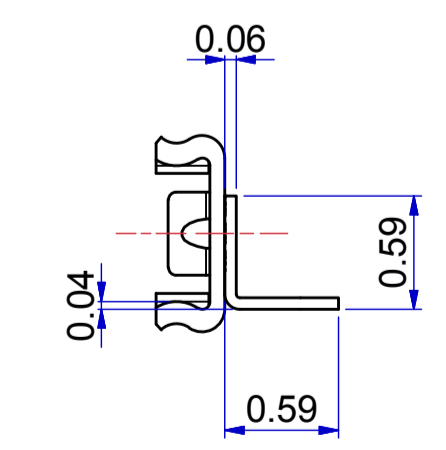
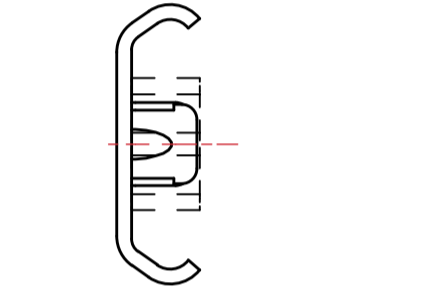
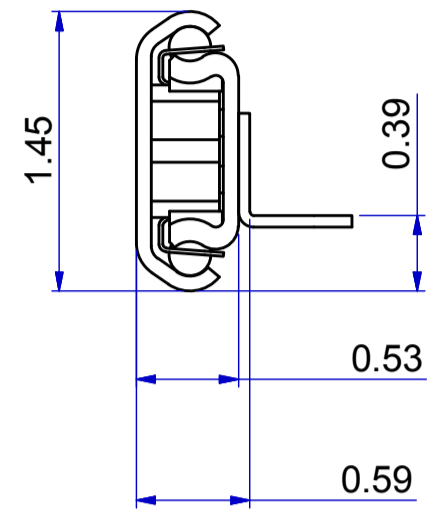
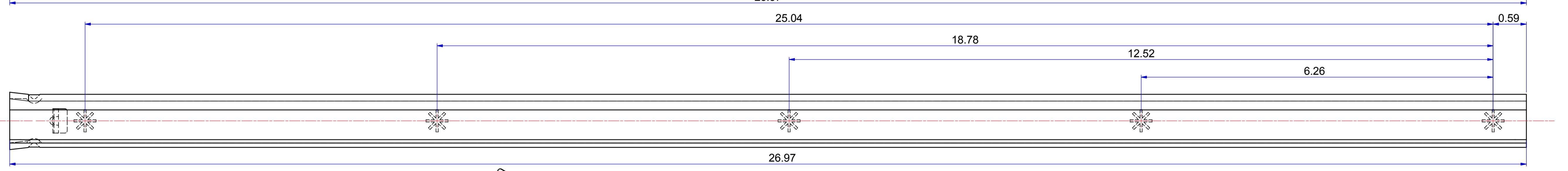
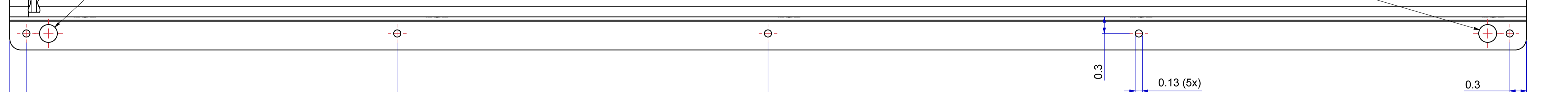

511-07-247-FA1

513-07-247-FA2

### Released for Production

Right hand side is shown part,  
Left hand side is opposite part.

Dimensions between marks are guide dimensions.

Thomas Regout Int. B.V. reserves the right to alter  
non-customer specific specifications without notice.

DIMENSIONS ARE CALCULATED FROM METRIC VALUES  
THOMAS REGOUT B.V. RESERVES THE RIGHT TO ALTER NON-CUSTOMER  
SPECIFICATIONS WITHOUT NOTICE

Designer	J. Bastings	Gen.Tol.Dim.	Third angle projection	Material	
Date	10-8-1994	Gen.Tol.Angle		Treatment	
Approver		Gen.Roughness		Draw type	Fabrication
Date		Units	Inch/deg	Scale	1 : 1
Description		FINN 700 / 541 (13,5mm) [27.56"/21.29"(0.531")]			
Format	A1	Item No.	107-247_Inch	Revision	00

Released for Production

© THOMAS REGOUT INTERNATIONAL BV, Industrieweg 40, 6219 NR, Maastricht, The Netherlands, +31 (0)43 351 66 66 All rights are reserved.

02	-	-	-
00	16-02-2017	SLEUFGAT + OPHANGGAT 8mm VERWIJDERD IN FA2	M. MAHIEU
00	15-06-2015	GETEKEND IN INVENTOR, LASPUNTEN	W. Jans
Rev	Date	Description	Designer